

# AFFI

# S75-LAW/140

A	B	C	D
1	S75-101	446	598
2	S75-201	1401	600
3	S75-301	1323	596
4	S75-401	1323	60

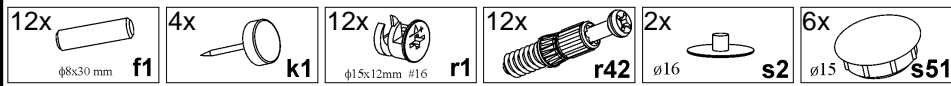
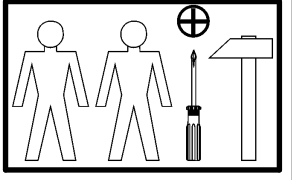
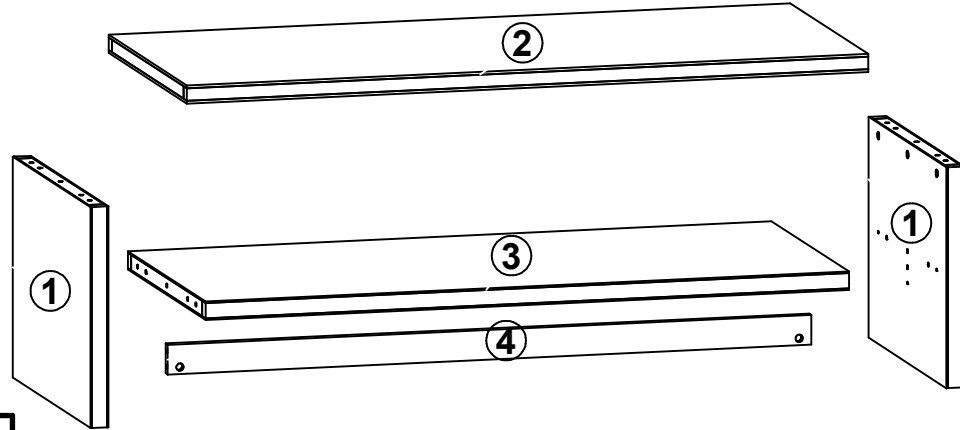

## 1 §2

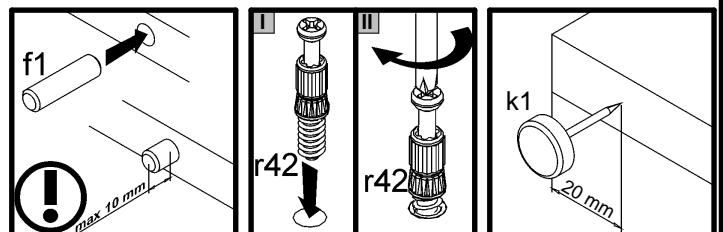
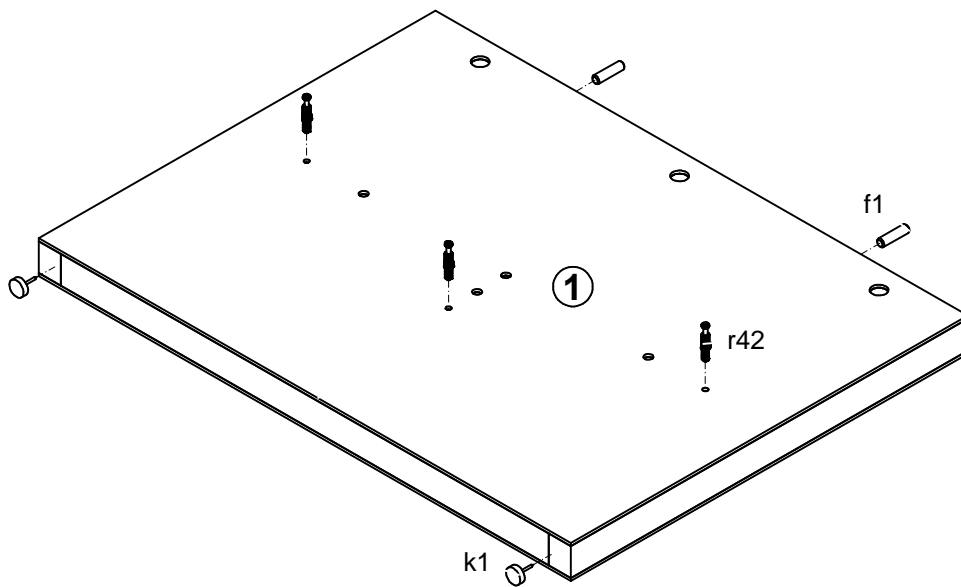

# 2

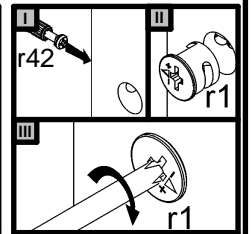
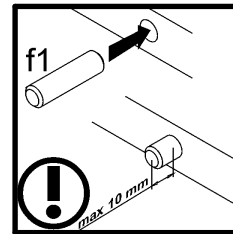
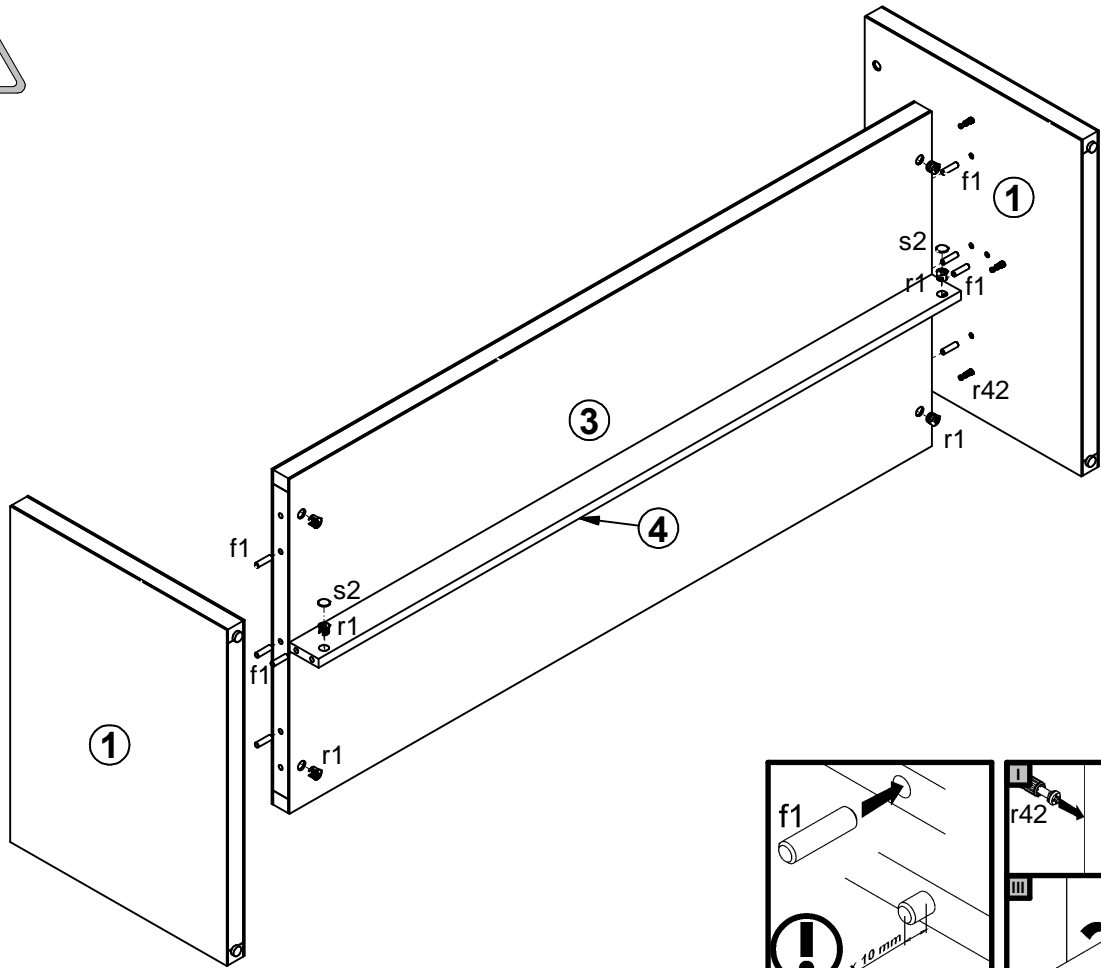

# 3

